

LANGHAM BUNK BED ASSEMBLY INSTRUCTION

IMPORTANT : PLEASE DO NOT REMOVE THIS STICKER.



WARNING

- This bunk's conforms to be EN 747-1:2024
- This upper bed is not suitable for children under six years.
- Ensure thickness of mattress does not exceed 14.5cm.

PLEASE DO NOT REMOVE THIS LABEL
THIS IS PERMANENT LABEL

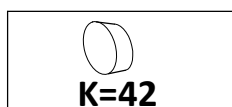
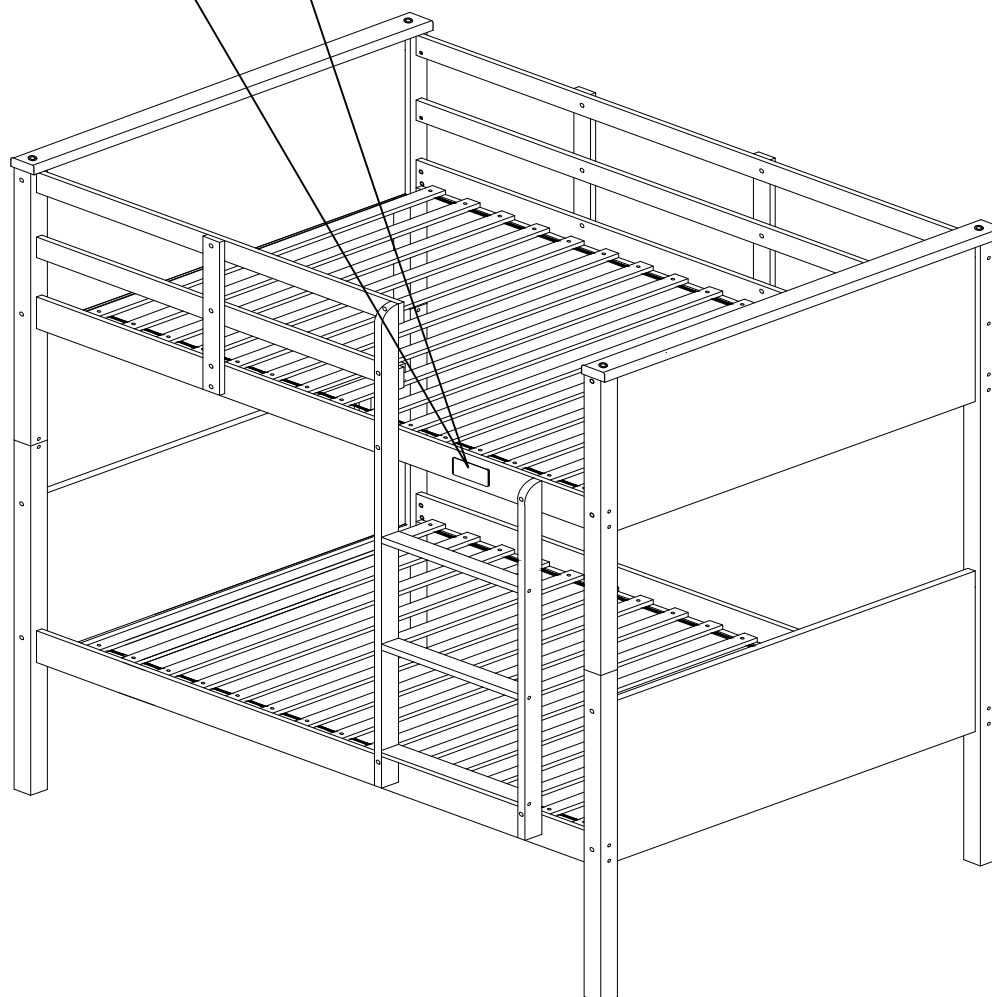

FULL SETUP

**TIGHTEN ALL THE JCBC SCREWS AND THEN
PLACES WOOD BUTTON TO ALL THE HOLES.**

LANGHAM BUNK BED ASSEMBLY INSTRUCTION

Thank you for purchasing this quality product. Be sure to check all packing material carefully for small parts which may have come loose inside the carton during shipment. Separate, identify and count all parts and hardware. Compare with the parts list to be sure all parts are present.

IMPORTANT : PLEASE READ INSTRUCTION BEFORE STARTING THE ASSEMBLY.

"DO NOT TIGHTEN SCREWS UNTIL COMPLETELY ASSEMBLED"

"DO NOT OVERTIGHT ANY HARDWARE"

WARNING : SMALL PARTS AND HARDWARE NOT FOR CHILDREN UNDER 3 YEARS. ADULT ASSEMBLY REQUIRED.

TABLE OF CONTENTS

IMPORTANT NOTICE	PAGE 2
HARDWARES LIST	PAGE 3
PARTS LIST	PAGE 4
PARTS' LOCATION	PAGE 5
ASSEMBLY STEPS	PAGE 6 - 10
ASSEMBLY COMPLETED	PAGE 11

ASSEMBLY TOOL REQUIRED

1. Screwdriver (not provide)



LANGHAM BUNK BED ASSEMBLY INSTRUCTION

IMPORTANT - READ THESE INSTRUCTION CAREFULLY BEFORE ASSEMBLING THE BED.

IMPORTANT - READ CAREFULLY - RETAIN FOR FUTURE REFERENCE.

HEALTH & SAFETY:

DO NOT jump on the bed frame.

DO NOT use this bed frame if any parts are missing, damage or worn.

DO NOT use this bed frame unless all fixing are secured.

Please keep small parts out of reach of children.

Always use on a level, even surface.

This bed is tested to European safety standard **EN 747-1:2024**

WARNING : The upper bed is not suitable for use by children under six years of age due to risk of injury from falls.

WARNING : High bed and bunk beds can present a serious risk of injury from strangulation if not used correctly . Never attach or hang anything on any part of the frame that is not designed to be used with the bed. for example but not limited to ropes, strings, cords, hooks, belts, and bags.

WARNING : Do not use the high bed and bunk beds if any structure part is broken or missing.

WARNING : Children can become trapped between the bed and the wall, a roof pitch, the ceiling, adjoining pieces of furniture(e.g. cupboards) and the like. To avoid risk of serious injury the distance between the top safety barrier and the adjoining structure shall not exceed 75mm or shall be more than 230mm.

WARNING : Always ensure the platform and the ladder / stairs are permanently attached to this bunk bed before use.

- Always follow the manufacturer's instructions.

CARE & MAINTENANCE :

Assemble in the room of use.

Assemble on a soft, clean surface.

Please check regularly that all assembly fastening are properly tighten.

DO NOT push the bed frame as this will damage the legs.

Always lift the bed with two people to reposition.

Use a soft, dry cloth to clean - do not use any detergents or chemicals.

Avoid contact with water and direct sunlight. Ventilation is necessary. Do not place bed near heat sources, window to keep the humidity low and prevent mould in and around the bed.

INFORMATION

- Maximum thickness of mattress 14.5 cm.

- Recommend size of mattress for this bunk bed is L 190cm x W 90cm x H 14.5cm.

- When you are ready to start, make sure that you have the right tools, plenty of space on a clean, dry area for assembly.

- Check the pack to make sure that you have all the part listed.

- Ensure that this product is fully assembly and secured as illustrated before use.





- Importer : Bedcare Ltd / Reinforced Beds

- Importer address : West Holme Nursery, 65 Station Road North, Walpole Cross Keys, King Lynn, norfolk, PE34 4HB

LANGHAM BUNK BED ASSEMBLY INSTRUCTION

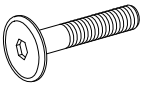
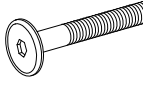
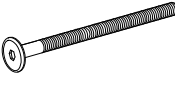
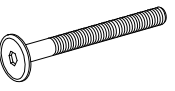
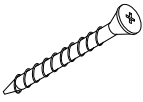
HARDWARES LIST

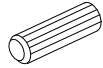
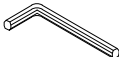
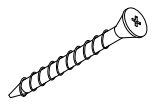
You can use letters or numbers here.

<p>A </p> <p>(A) M6 X 40MM JCBC SCREW - (GUARDRAIL)</p>	<p>QTY</p> <p>13</p>	<p>B </p> <p>(B) M6 X 50MM JCBC SCREW - (LADDER)</p>	<p>QTY</p> <p>6</p>	<p>C </p> <p>(C) M6 X 110MM JCBC SCREW</p>	<p>QTY</p> <p>38</p>
<p>D </p> <p>(D) M6 X 60MM JCBC SCREW - (LADDER)</p>	<p>6</p>	<p>E </p> <p>(E) M4 X 32MM CSK SCREW</p>	<p>52</p>	<p>F </p> <p>(F) BARREL NUT M6 X 15MM</p>	<p>44</p>
<p>G </p> <p>(G) WOOD DOWEL M10 X 40MM</p>	<p>30</p>	<p>H </p> <p>(H) WOOD DOWEL M16 X 65MM</p>	<p>4</p>	<p>I </p> <p>(I) M4 ALLEN KEY</p>	<p>2</p>
<p>J </p> <p>(J) M4 X 45MM CSK SCREW</p>	<p>8</p>	<p>K </p> <p>(K) WOOD BUTTON</p>	<p>42</p>		









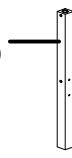

Important

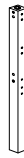
1. Before you throw the package , please use the Check Box to identify the parts and hardware to ensure that you have everything you need.
2. Check and measure the bolts before applying them to parts.
3. Do not completely tighten all hardware until the entire assembly is complete, unless indicate otherwise.

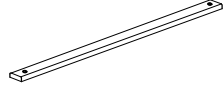
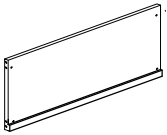
LANGHAM BUNK BED ASSEMBLY INSTRUCTION

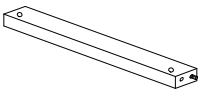
PARTS LIST

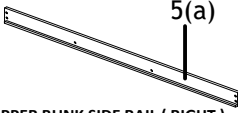
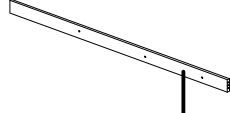
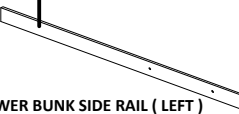
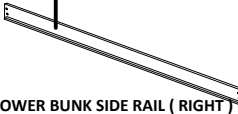
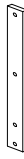
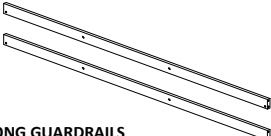
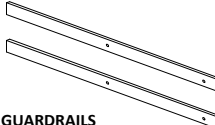
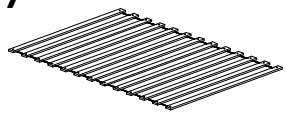
1(i)  1(i) (no hole for fencing) (1 pc) UPPER BUNK POST 1(i) - (no hole for fencing)	QTY <div style="border: 1px solid black; padding: 2px; width: 20px; margin: 0 auto;">1</div>	1(ii)  1(ii) (3 pcs (hole for fencing) UPPER BUNK POST 1(ii) - (hole for fencing)	QTY <div style="border: 1px solid black; padding: 2px; width: 20px; margin: 0 auto;">2</div>	1(iii)  UPPER BUNK POST 1(iii) - (hole for fencing)	QTY <div style="border: 1px solid black; padding: 2px; width: 20px; margin: 0 auto;">1</div>
2(i)  LOWER BUNK POST 2(i)	QTY <div style="border: 1px solid black; padding: 2px; width: 20px; margin: 0 auto;">2</div>	2(ii)  LOWER BUNK POST 2(ii)	QTY <div style="border: 1px solid black; padding: 2px; width: 20px; margin: 0 auto;">2</div>	3(i)  TOP RAIL	<div style="border: 1px solid black; padding: 2px; width: 20px; margin: 0 auto;">2</div>
3(ii)  UPPER & LOWER BUNK HEADBOARD	<div style="border: 1px solid black; padding: 2px; width: 20px; margin: 0 auto;">4</div>	4(i)  LONG LADDER POST (LEFT)	<div style="border: 1px solid black; padding: 2px; width: 20px; margin: 0 auto;">1</div>	4(ii)  LADDER STEP	<div style="border: 1px solid black; padding: 2px; width: 20px; margin: 0 auto;">3</div>
4(iii)  SHORT LADDER POST (RIGHT)	<div style="border: 1px solid black; padding: 2px; width: 20px; margin: 0 auto;">1</div>	5(a)  UPPER BUNK SIDE RAIL (RIGHT)	<div style="border: 1px solid black; padding: 2px; width: 20px; margin: 0 auto;">1</div>	5(b)  UPPER BUNK SIDE RAIL (LEFT)	<div style="border: 1px solid black; padding: 2px; width: 20px; margin: 0 auto;">1</div>
5(c)  LOWER BUNK SIDE RAIL (LEFT)	<div style="border: 1px solid black; padding: 2px; width: 20px; margin: 0 auto;">1</div>	5(d)  LOWER BUNK SIDE RAIL (RIGHT)	<div style="border: 1px solid black; padding: 2px; width: 20px; margin: 0 auto;">1</div>	6(i)  FENCING SUPPORT	<div style="border: 1px solid black; padding: 2px; width: 20px; margin: 0 auto;">3</div>
6(ii)  LONG GUARDRAILS	<div style="border: 1px solid black; padding: 2px; width: 20px; margin: 0 auto;">1</div>	6(iii)  SHORT GUARDRAILS	<div style="border: 1px solid black; padding: 2px; width: 20px; margin: 0 auto;">1</div>	7  WOODEN SLAT	<div style="border: 1px solid black; padding: 2px; width: 20px; margin: 0 auto;">2</div>



Important

1. Before you throw the package , please use the Check Box to identify the parts and hardware to ensure that you have everything you need.
2. Check and measure the bolts before applying them to parts.
3. Do not completely tighten all hardware until the entire assembly is complete, unless indicate otherwise.

LANGHAM BUNK BED ASSEMBLY INSTRUCTION

PARTS' LOCATION

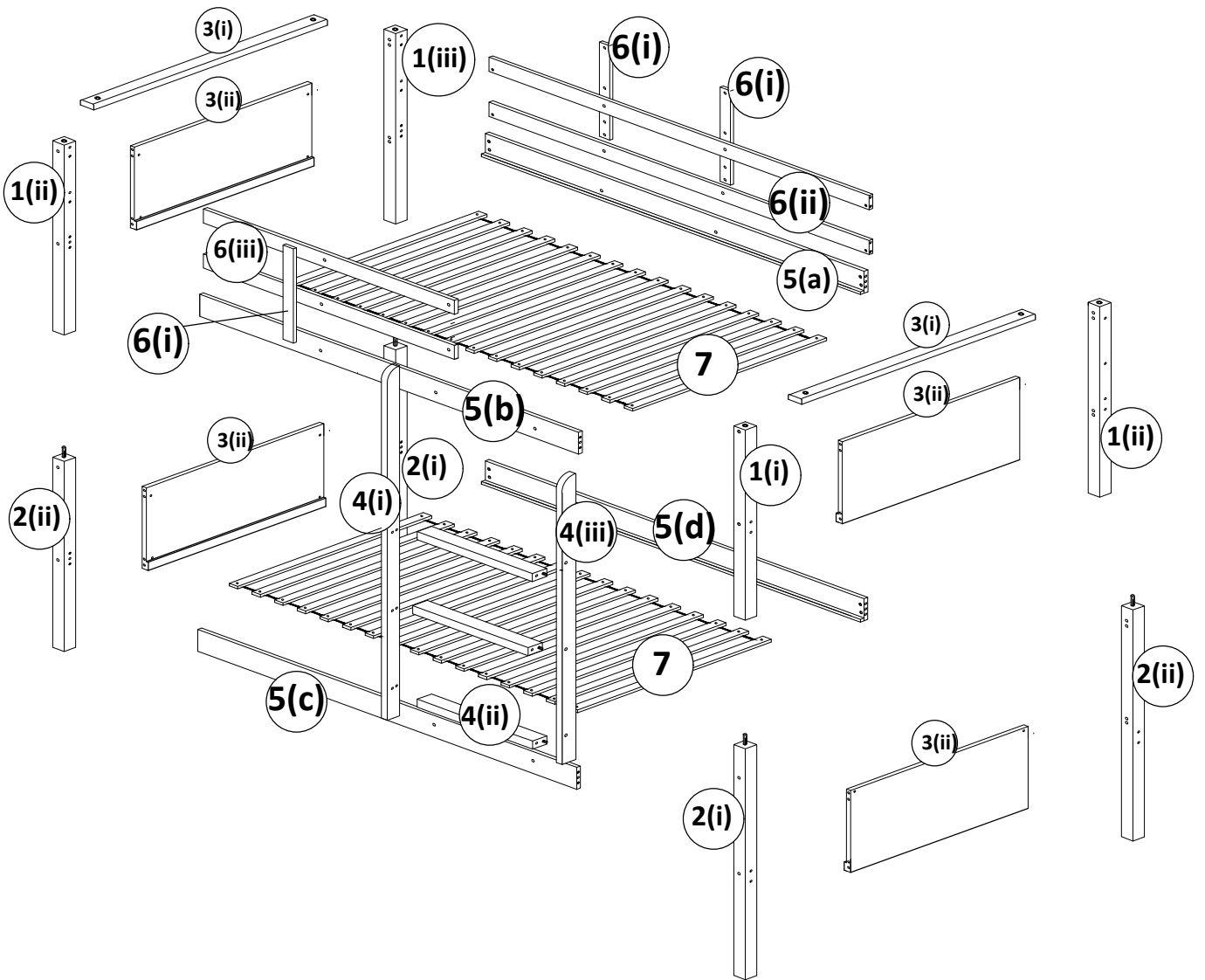
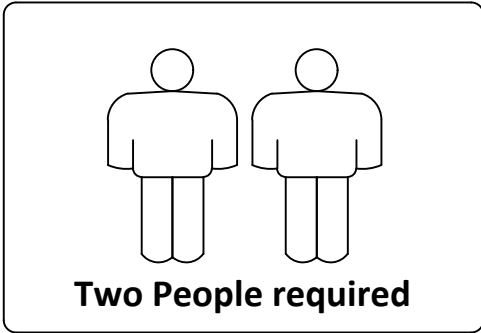

LANGHAM BUNK BED ASSEMBLY INSTRUCTION

Step 1 LOWER BUNK POST AND HEADBOARD ASSEMBLY

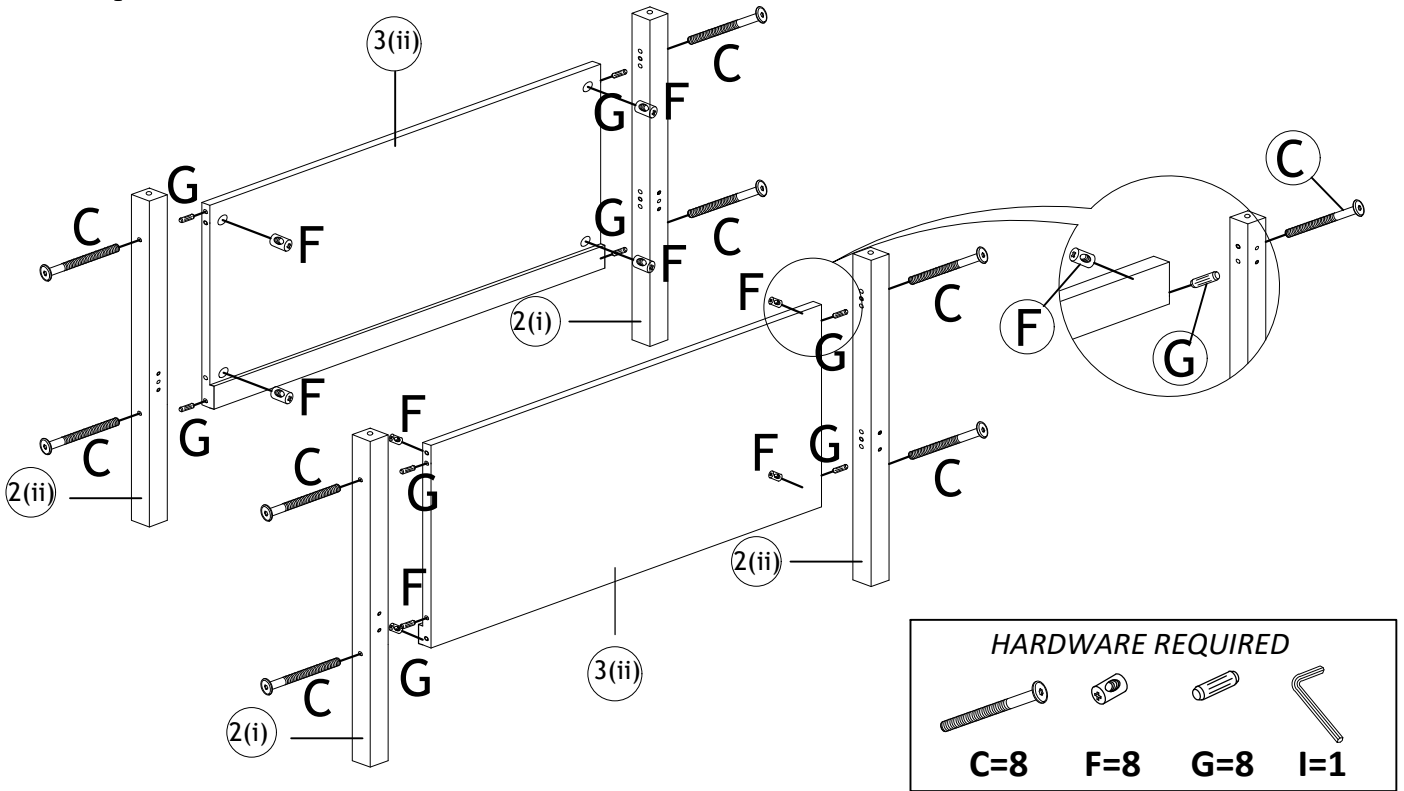

Step 2 LOWER BUNK HEADBOARD AND SIDE RAIL ASSEMBLY

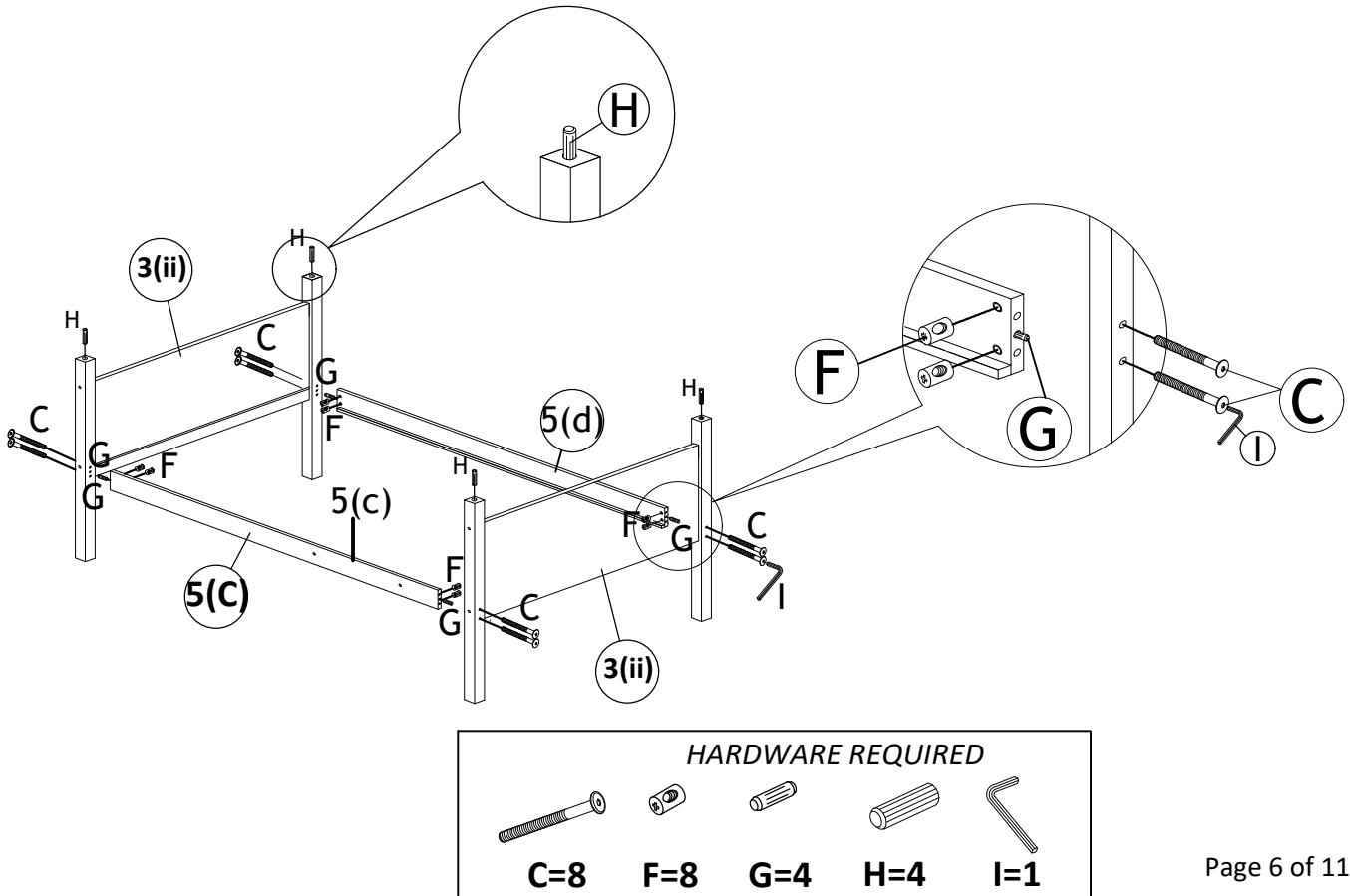

LANGHAM BUNK BED ASSEMBLY INSTRUCTION

Step 3 UPPER BUNK POST AND HEADBOARD ASSEMBLY

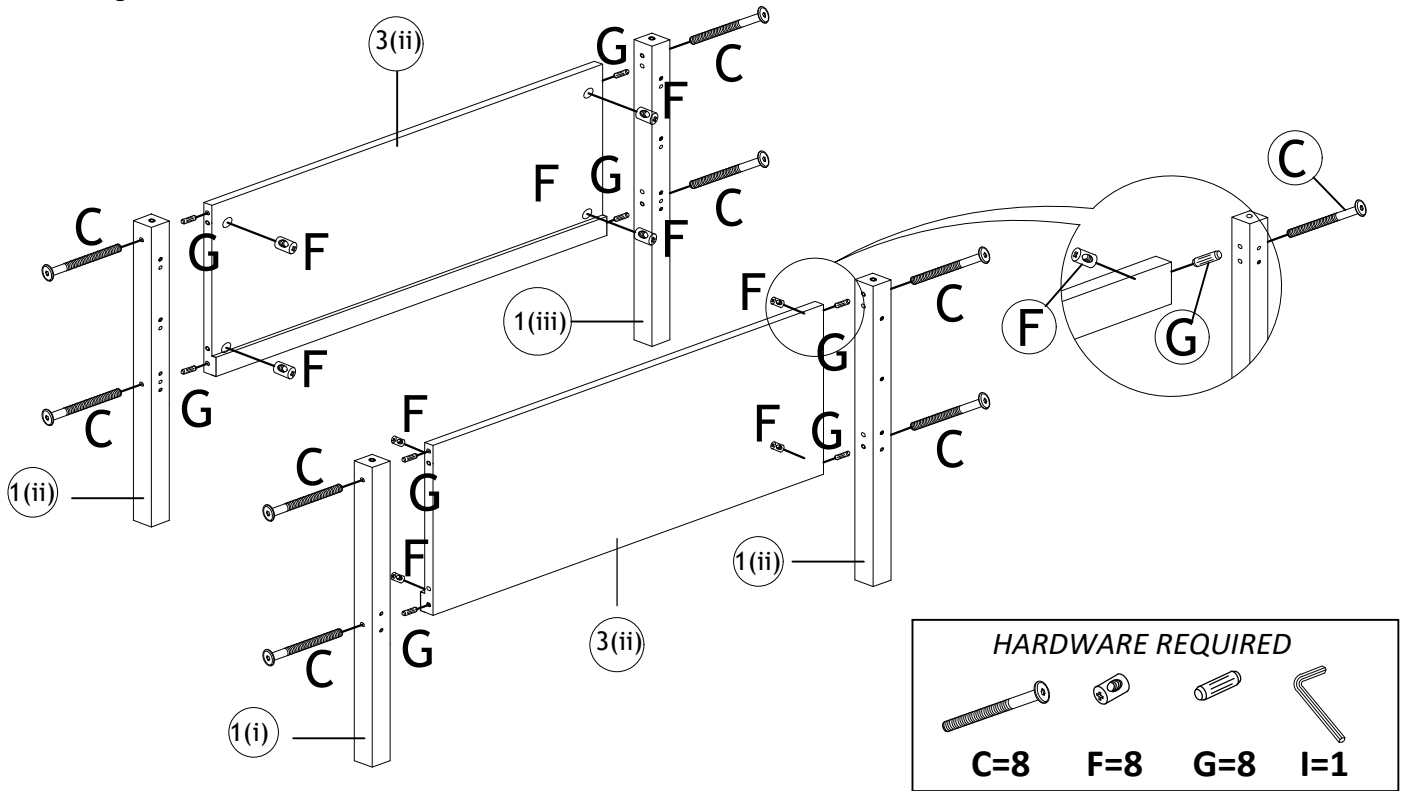

Step 4 LONG GUARDRAIL ASSEMBLY

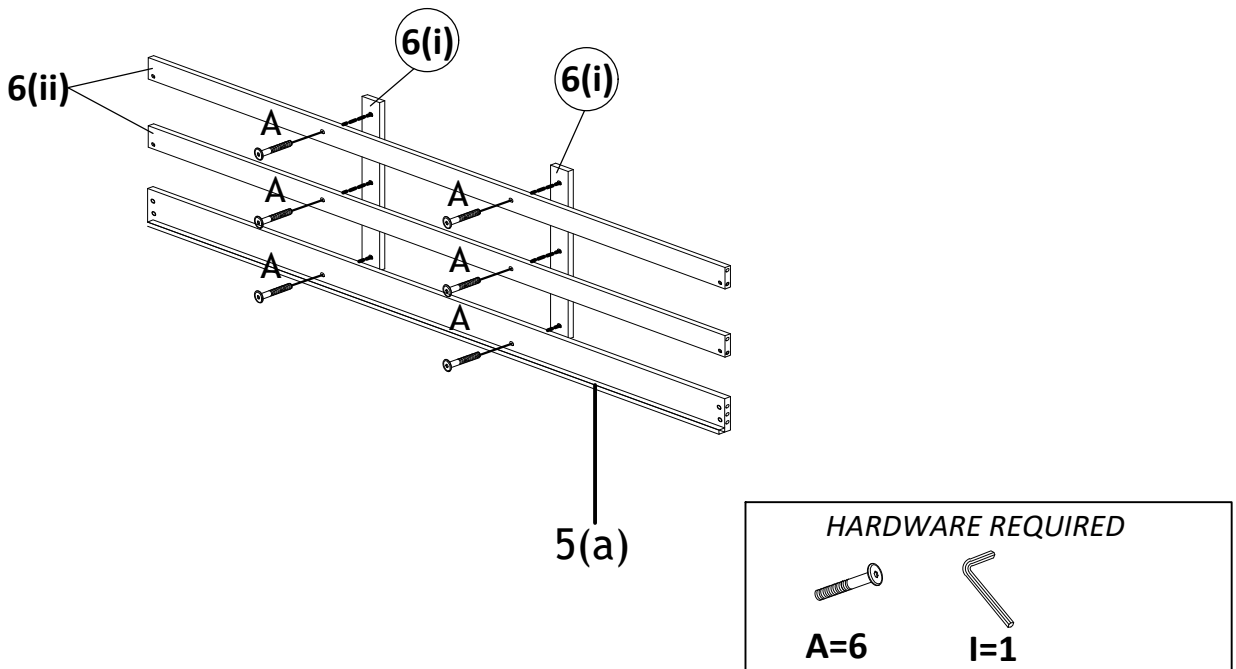

LANGHAM BUNK BED ASSEMBLY INSTRUCTION

Step 5 UPPER BUNK HEADBOARD AND SIDE RAIL ASSEMBLY TOP RAIL ASSEMBLY

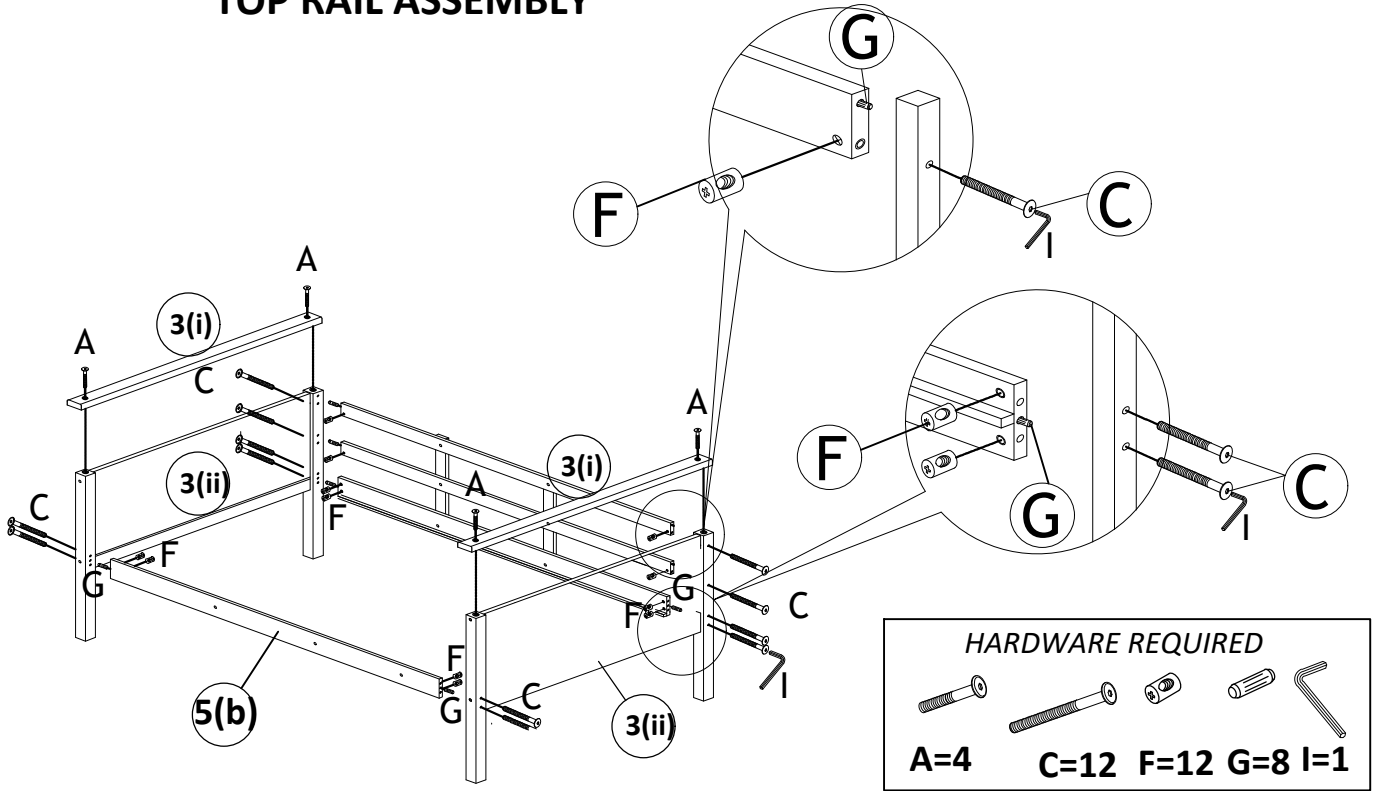

Step 6 CARRY UPPER BUNK TO PLACE ON LOWER BUNK ASSEMBLY

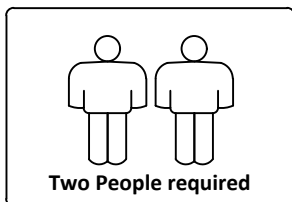
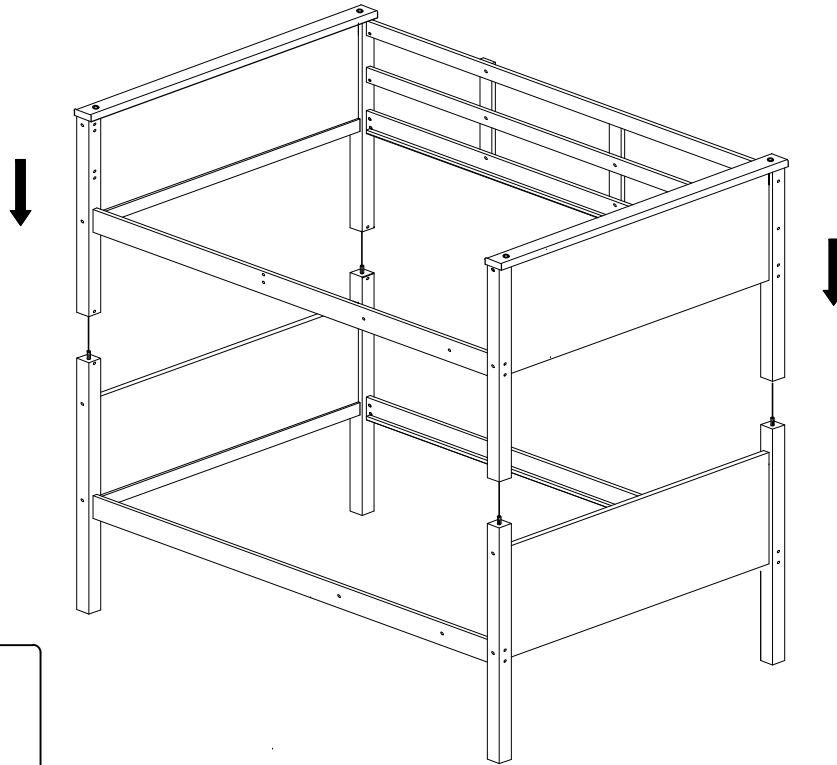





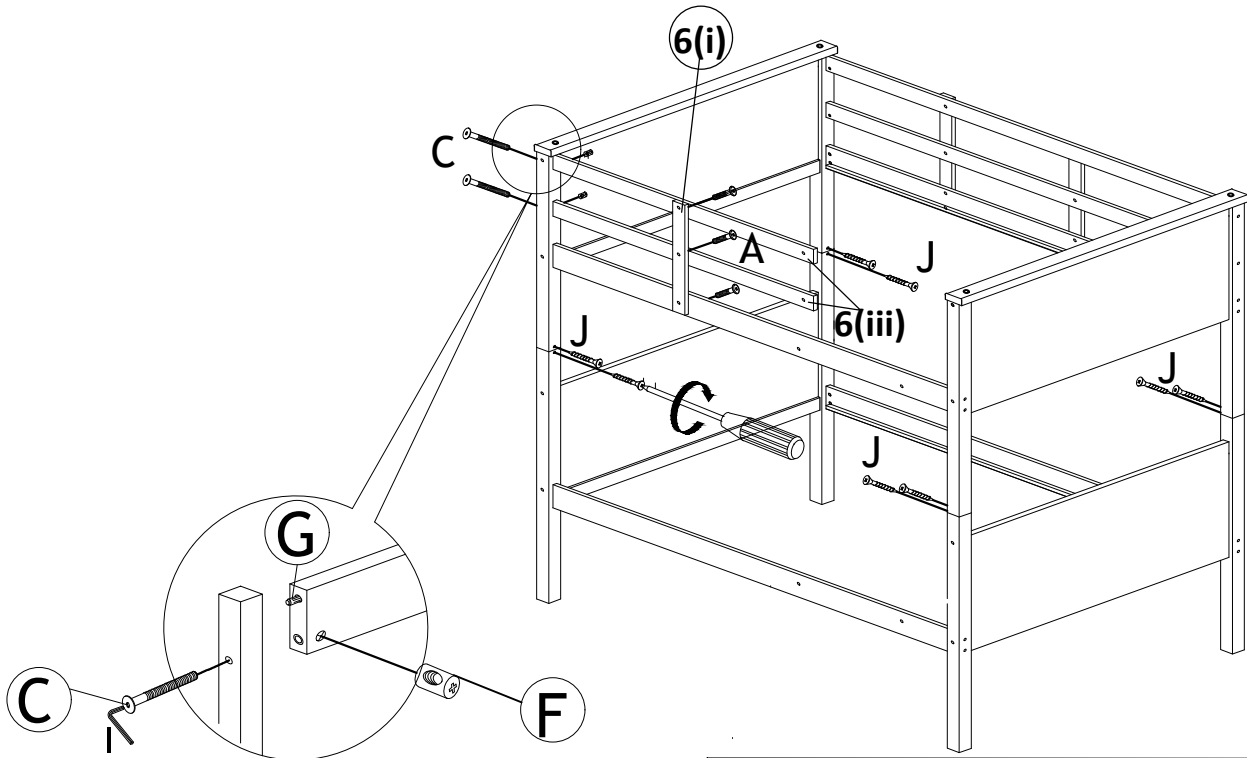

LANGHAM BUNK BED ASSEMBLY INSTRUCTION

Step 7 SHORT GUARDRAIL ASSEMBLY



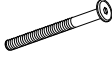



REQUIRED ASSEMBLY TOOLS:
POZI SCREWDRIVER - 1PC

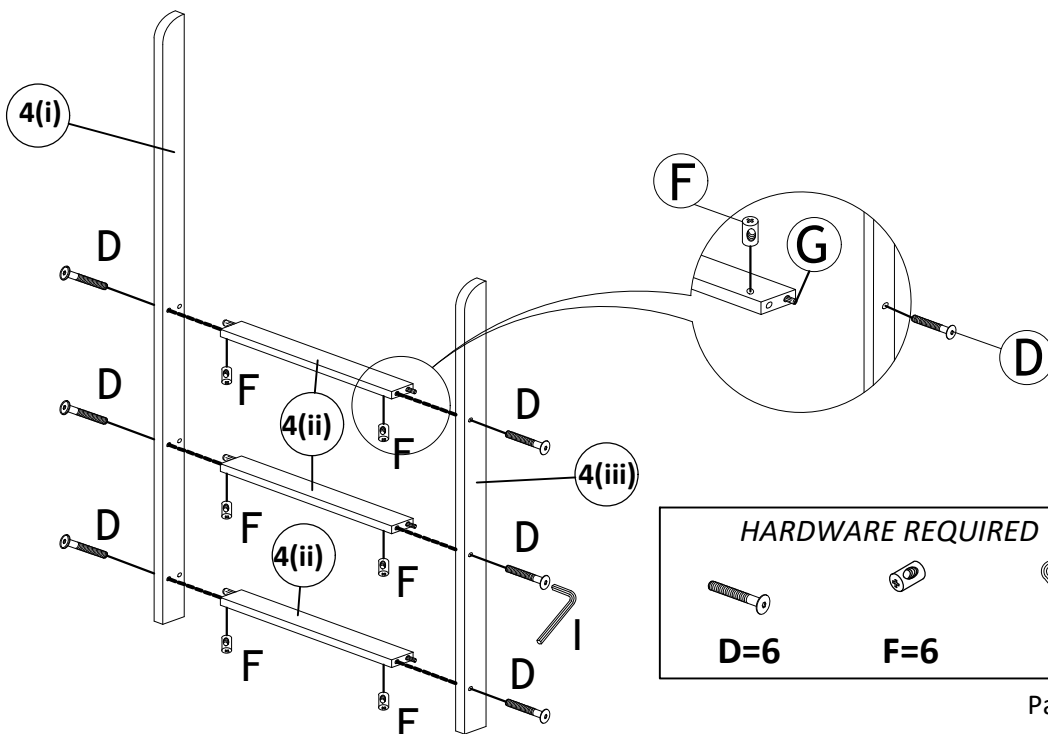

HARDWARE REQUIRED					
					
J=8	A=3	C=2	F=2	G=2	I=1

Step 8 LADDER ASSEMBLY



HARDWARE REQUIRED		
		
D=6	F=6	I=1

LANGHAM BUNK BED ASSEMBLY INSTRUCTION

Step 9

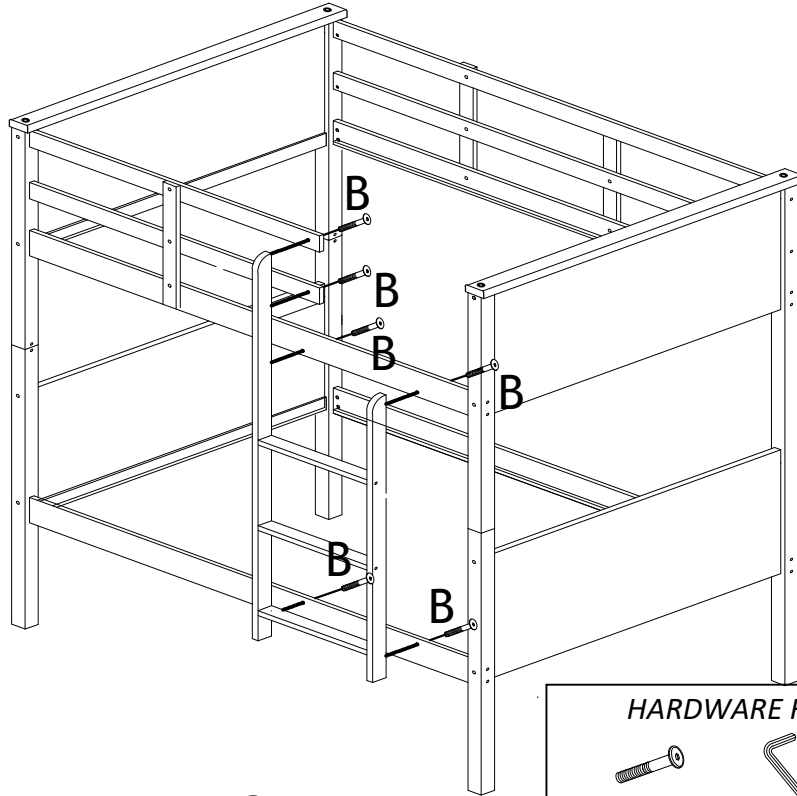

LADDER FIXED AT UPPER AND LOWER BUNK

HARDWARE REQUIRED

B=6 **I=1**

Step 10

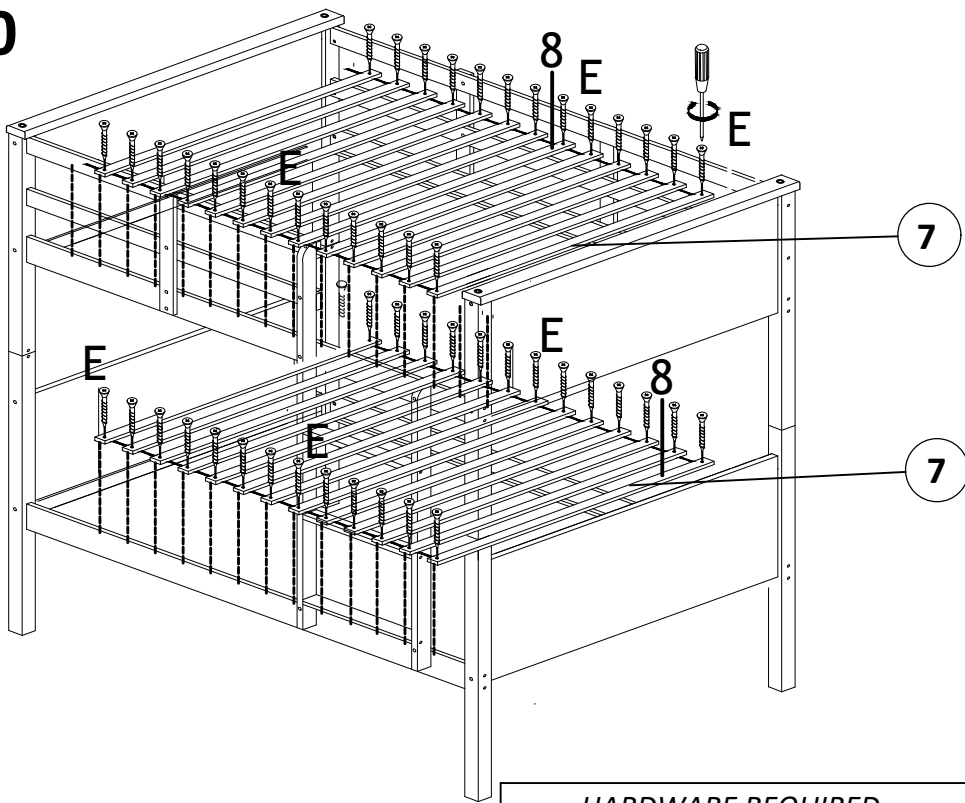

WOODEN SLAT ASSEMBLY

HARDWARE REQUIRED

E=52

REQUIRED ASSEMBLY TOOLS:
POZI SCREWDRIVER - 1PC